

GR-200EX

(Right-hand drive)

20 Ton Capacity

SPEC. SHEET NO. GR-200E-3-00101/EX-02

HYDRAULIC ROUGH TERRAIN CRANE

DIMENSIONS

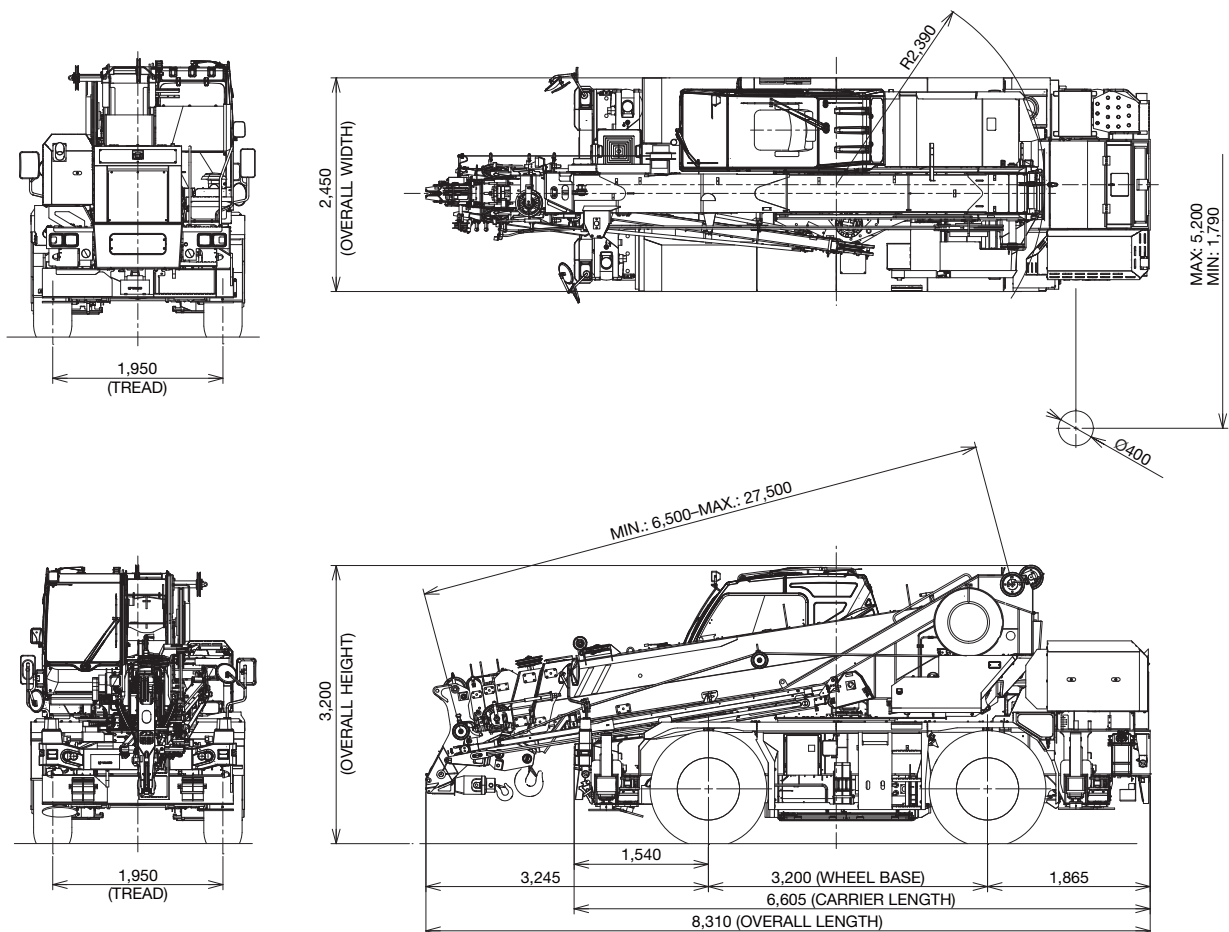

Note: In this external views, a few equipment are included.

GENERAL DIMENSIONS

Turning radius (445/80R25 Tires)		Overall length	approx. 8,310 mm
4 wheel steer	5.7 m	Overall width	approx. 2,450 mm
2 wheel steer	10.4 m	Overall height	approx. 3,200 mm

CRANE SPECIFICATIONS

BOOM

6 section full power partially synchronized telescoping boom of rectangular box construction with 3 sheaves at boom head. The synchronization system consists of 2 telescope cylinders, extension cables and retraction cables. Hydraulic cylinder fitted with holding valve. An easily removable wire rope guard, rope dead end provided on the left side of boom head. Boom telescope sections are supported by wear pads both vertically and horizontally.

Fully retracted length.....	6.5 m
Fully extended length.....	27.5 m
Extension speed.....	21.0 m in 71 s
Root diameter.....	0.238 m

BOOM ELEVATION

By a double acting hydraulic cylinder with holding valve. Combination controls for hand or foot operation. Boom angle indicator.

Automatic speed reduction and slow stop function.	
Boom angle.....	-9°– 82.5°
Boom raising speed.....	-9° to 82.5°/30 s

JIB

2 stage boom under slung type with offset angle by offset cylinder. Single sheave at jib head.

Box type top section telescopes from box type base section which stows under base boom section.

Length.....	4.5 m, 6.9 m
Offset.....	5°– 60°
Root diameter.....	0.238 m

AUXILIARY LIFTING SHEAVE (SINGLE TOP)

Single sheave mounted to main boom head for single line work. Root diameter..... 0.238 m

ANTI-TWO-BLOCK DEVICE

Pendant type over-winding cut out device with audio-visual (FAILURE lamp/BUZZER) warning system.

SLEWING

Hydraulic axial piston motor driven through planetary slewing speed reducer. Continuous 360° full circle slewing on ball bearing. Equipped with manually locked/released slewing brake.

Slewing speed.....	2.6 min ⁻¹ {rpm}
--------------------	-----------------------------

WINCH

MAIN WINCH

Variable speed type with grooved drum driven by hydraulic axial piston motor through speed reducer. Power load lowering and raising.

Equipped with automatic brake (neutral brake) and counterbalance valve. Controlled independently of auxiliary winch. Equipped with drum rotation indicator.

MAIN DRUM

Root diameter x wide.....	0.308 m x 0.312 m
Wire rope diameter x length.....	14.0 mm x 155 m
Drum capacity.....	174.9 m, 7 layers
Maximum single line pull (1st layer).....	52.6 kN (5,370 kgf)
Maximum permissible line pull wire strength.....	28.4 kN (2,900 kgf)

AUXILIARY WINCH

Variable speed type with grooved drum driven by hydraulic axial piston motor through speed reducer. Power load lowering and raising.

Equipped with automatic brake (neutral brake) and counterbalance valve. Controlled independently of main winch. Equipped with drum rotation indicator.

AUXILIARY DRUM

Root diameter x wide.....	0.308 m x 0.312 m
Wire rope diameter x length.....	14.0 mm x 85 m
Drum capacity.....	174.9 m, 7 layers
Maximum single line pull (1st layer).....	52.6 kN (5,370 kgf)
Maximum permissible line pull wire strength.....	31.4 kN (3,200 kgf)

WIRE ROPE

Filler or warrington seal wire (spin-resistant), extra improved plow steel, preformed, independent wire rope core, right regular lay.

Main.....	14.0 mm	IWRC6 x WS (31)
Auxiliary.....	14.0 mm	IWRC6 x WS (31)

HOOK BLOCKS

20 ton

3 sheaves with swivel hook and safety latch

3.2 ton

Weighted hook with swivel and safety latch

HYDRAULIC SYSTEM

PUMPS

2 variable piston pumps for crane functions.

Tandem gear pump for steering, slewing and optional equipment. Powered by carrier engine. Pump disconnect for crane is engaged/disengaged by rotary switch from operator's cab.

CONTROL VALVES

Electrically controlled multiple hydraulic valves with integral pressure relief valves.

RESERVOIR

285 liters capacity. External sight level gauge.

FILTRATION

BETA10=10 return filter, full flow with bypass protection, located inside of hydraulic reservoir. Accessible for easy replacement.

OIL COOLER - Air cooled fan type.

CAB AND CONTROLS

Both crane and drive operations can be performed from one cab mounted on rotating superstructure.

Right side, 1 man type, steel construction with sliding door access and safety glass windows opening at side. Door window is powered control. Windshield glass window and roof glass window are shatter-resistant. Wiper and washer (front windshield and roof window). Tinted safety glass and sun visor. Tilt-telescoping steering wheel. Adjustable control levers for slewing, boom elevating, boom telescoping, auxiliary winch and main winch. Control levers can change neutral positions and tilt for easy access to cab. Foot operated controls: auxiliary winch, boom telescoping, service brake and engine throttle. 3 way adjustable operator's suspension seat with high back, headrest and armrest. Cab floor mat. Engine throttle knob. Hot water cab heater and air conditioning.

Dash-mounted Instruments panel, Multi Function Display, Starter switch (engine start/stop), Drive mode selector switch, Parking brake switch, Steering mode selector switch, Power window switch, PTO switch (pump engaged/disengaged), Air conditioning control panel.

Instruments panel -

Speedometer, Tachometer, Odo/trip/hour meter.
Torque converter oil temperature gauge, Water temperature gauge, Air pressure gauge, Fuel gauge.

Multi Function Display -

DEF/AdBlue level gauge, Fuel consumption monitor.

CRANE SPECIFICATIONS

TADANO Automatic Moment Limiter

(AML-E) including:

- Control lever lockout function with audible and visual pre-warning
- Number of parts of line
- Boom position indicator
- Outrigger state indicator
- Slewing angle
- Boom angle / boom length / jib offset angle / jib length / load radius / rated lifting capacities / actual loads read out
- Potential lifting height
- Ratio of actual load moment to rated load moment indication
- Permissible load
- Automatic Speed Reduction and Slow Stop function on boom elevation and slewing
- Working condition register switch
- Load radius / boom angle / tip height / slewing range preset function

- External warning lamp
- Tare function
- Main hydraulic oil pressure
- Fuel consumption monitor
- Drum rotation indicator (audible and visible type) main and auxiliary winch
- On-rubber indicator

TADANO AML-E monitors outrigger extended length and automatically programs the corresponding "RATED LIFTING CAPACITIES" table

Operator's left hand console includes transmission gear selector, sight level bubble and outrigger control panel, electrical power socket, boom telescoping/jib tilt operation selector switch.

NOTE: Each crane motion speed is based on unladen conditions.

CARRIER SPECIFICATIONS

TYPE

Rear engine, right-hand drive, driving axle 2-way selected type by manual switch, 4x2 front drive, 4x4 front and rear drive.

FRAME

High tensile steel, all welded mono-box construction.

ENGINE

Model	Cummins QSB6.7-4C [EU Stage IV, U.S. Tier4]
Type	Direct injection diesel
No. of cylinders	6
Combustion	4 cycle, turbo charged and after cooled
Bore x Stroke, mm	107 x 124
Displacement, liters	6.690
Air inlet heater	24 volt preheat
Air cleaner	Dry type, replaceable element
Oil filter	Full flow with replaceable element
Fuel filter	Full flow with replaceable element
Fuel tank, liters	250, right side of carrier
Cooling	Liquid pressurized, recirculating by-pass
Radiator	Fin and tube core, thermostat controlled
Fan, mm	Suction type, 9-blade, 711 dia.
Starting	24 volt
Charging	24 volt system, negative ground
Battery	2-96 amp. Hour
Compressor, air, l/min	481 at 2,400 min ⁻¹
Output, Max. kW (HP)	Gross 175 (238) at 2,300 min ⁻¹
Torque, Max. N·m	888 at 1,500 min ⁻¹
Capacity, liters	
Cooling water	10
Lubrication	15
Fuel	250
DEF/Ad Blue	19

TRANSMISSION

Electronically controlled full automatic transmission.

Torque converter driving full power shift with driving axle selector.

6 forward and 2 reverse speeds, constant mesh.

3 speeds - high range - 2-wheel drive; 4-wheel drive

3 speeds - low range - 4-wheel drive

TRAVEL SPEED - 54 km/h

GRADE ABILITY (tan θ) - 66% (at stall), 57% *

* Machine should be operated within the limit of engine crankcase design (30°: Cummins QSB6.7-4C)

AXLE

Front: Full floating type, steering and driving axle with planetary reduction.

Rear: Full floating type, steering and driving axle with planetary reduction.

STEERING

Hydraulic power steering controlled by steering wheel.

4 steering modes available: 2 wheel front, 2 wheel rear, 4 wheel coordinated and 4 wheel crab.

SUSPENSION

Front: Semi-elliptic leaf springs with hydraulic lockout device.

Rear: Semi-elliptic leaf springs with hydraulic lockout device.

BRAKE SYSTEMS

Service: Air over hydraulic disc brakes on all 4 wheels.

Parking/Emergency: Spring applied-air released brake acting on input shaft of front axle.

Auxiliary: Electro-pneumatic operated exhaust brake.

TIRES - 445/80R25 (OR) Air pressure: 700 kPa

OUTRIGGERS

4 hydraulic, beam and jack outriggers.

Vertical jack cylinders equipped with integral holding valve.

Each outrigger beam and jack is controlled independently from cab.

Beams extend to 5.2 m center-line and retract to within

1.79 m overall width with floats. Outrigger jack floats

are attached thus eliminating the need of manually attaching and

detaching them. Controls and sight bubble located in

superstructure cab. 4 outrigger extension lengths are provided

with corresponding "RATED LIFTING CAPACITIES" for crane duty in confined areas.

Min. Extension	1.79 m center to center
Mid. Extension	3.2 m center to center
Mid. Extension	4.4 m center to center
Mid. Extension	4.8 m center to center
Max. Extension	5.2 m center to center
Float size (Diameter)	0.4 m

STANDARD EQUIPMENT

- Telematics (machine data logging and monitoring system) with - HELLO-NET via internet (availability depends on countries)
- Eco mode system
- Positive control
- Emergency steering system
- Transmission neutral position engine start
- Overshift prevention
- Parking braked travel warning
- Tilt-telescope steering wheel
- LED head lamp
- Fenders
- Air dryer
- Water separator with filter (high filtration)
- Air cleaner dust indicator
- Full instrumentation package
- Towing hooks-Front and rear
- Tool storage compartment
- External warning lamp
- Side mirror with heating and electrical adjustment
- Centralized lubricating system (Carrier portion)
- Outrigger pads - Aluminum plates, Plastic plates
- Radio remote control system for preparing crane work
- Immobilizer
- Microphone control box
- Human Alert system
- Wide Sight View
- Winch drum camera
- Multi Function Display

HOISTING PERFORMANCE

LINE SPEEDS AND PULLS

Layer	Main or auxiliary winch - 0.308 m drum	
	Line speeds ¹	Line pulls Available ²
	m/min	kN (kgf)
1st	95	52.6 (5,370)
2nd	100	48.8 (4,980)
3rd	110	45.5 (4,640)
4th	115	42.7 (4,360)
5th	120	40.1 (4,090)
6th	130	37.9 (3,870)
7th ³	140	35.9 (3,660)

- Maximum permissible line pull wire strength.
Main: 28.4 kN (2,900 kgf) with IWRC6 x WS (31) class rope.
Auxiliary: 31.4 kN (3,200 kgf) with IWRC6 x WS (31) class rope.

¹ Line speed based only on hook block, not loaded.

² Developed by machinery with each layer of wire rope, but not based on rope strength or other limitations in machinery or equipment.

³ Seventh layer of wire rope are not recommended for hoisting operations.

DRUM WIRE ROPE CAPACITIES

Wire rope layer	Main or auxiliary drum grooved lagging	
	14.0 mm wire rope	
	Rope per layer	Total wire rope
	m	m
1	20.3	20.3
2	21.8	42.1
3	23.4	65.5
4	25.0	90.5
5	26.6	117.1
6	28.1	145.2
7	29.7	174.9

DRUM DIMENSIONS

Root diameter		308 mm
Length	Main	312 mm
	Auxiliary	312 mm
Flange diameter		520 mm

GR-200EX WORKING RANGE CHART

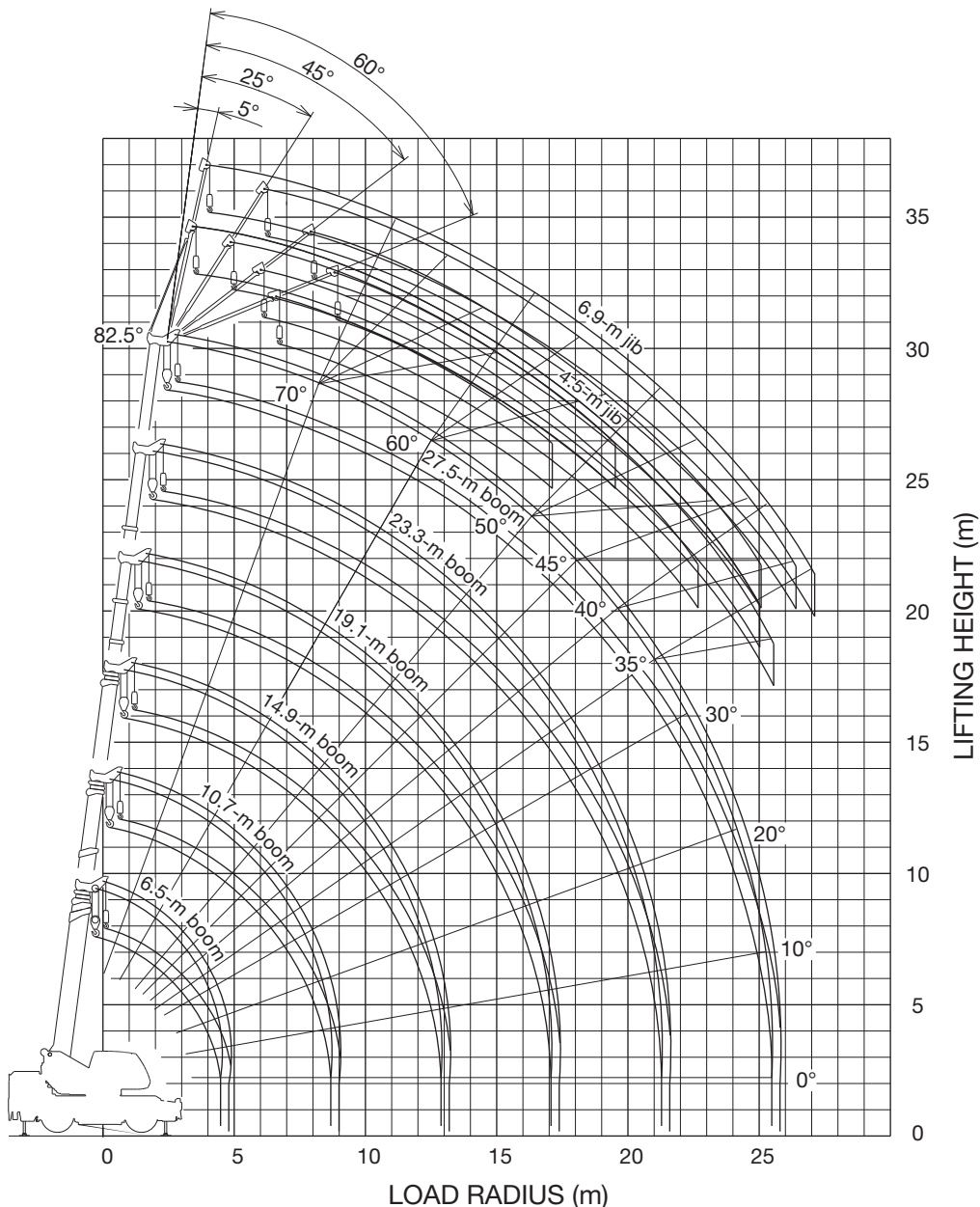

BOOM

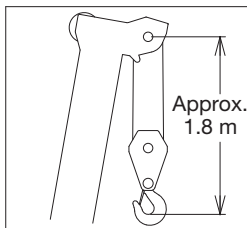

JIB

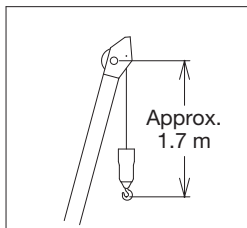

SINGLE TOP

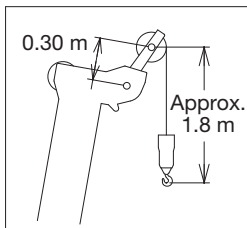

Boom Length

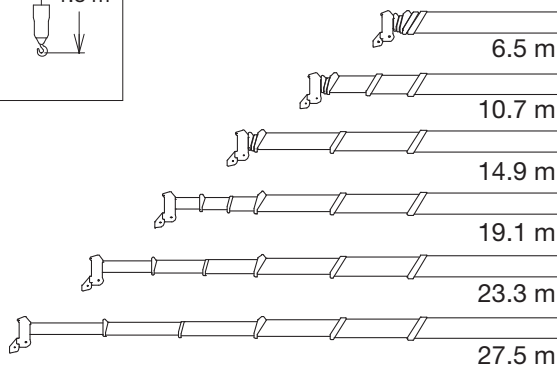

The above lifting height and boom angle are based on a straight (unloaded) boom and machine standing level on firm supporting surface. Allowance should be made for boom deflection obtained under loaded conditions. The above working range is shown on condition with outriggers fully (5.2 m) extended.

GR-200EX RATED LIFTING CAPACITIES

ON OUTRIGGERS FULLY EXTENDED 5.2 m SPREAD 360° ROTATION (Unit: x 1,000 kg)						
B \ A	6.5	10.7	14.9	19.1	23.3	27.5
2.5	20.0	12.0	9.0	7.0		
3.0	16.0	12.0	9.0	7.0		
3.5	14.0	12.0	9.0	7.0	5.0	3.5
4.0	12.5	12.0	9.0	7.0	5.0	3.5
4.5	11.7	11.1	9.0	6.6	4.95	3.5
5.0	(4.4m)	10.25	8.9	6.35	4.7	3.5
5.5		9.4	8.2	6.3	4.4	3.35
6.0		8.8	7.6	6.2	4.2	3.2
7.0		6.75	6.5	5.8	4.0	2.95
8.0		5.05	4.95	5.15	3.9	2.8
9.0		4.35	3.9	4.3	3.7	2.75
10.0		(8.6m)	3.1	3.45	3.3	2.65
11.0			2.5	2.85	3.05	2.4
12.0			2.0	2.35	2.65	2.2
13.0			1.7	1.95	2.2	2.05
14.0			(12.8m)	1.6	1.85	1.9
15.0				1.35	1.55	1.7
16.0				1.15	1.3	1.45
17.0				0.95	1.1	1.25
18.0					0.95	1.1
19.0					0.75	0.95
20.0					0.65	0.8
22.0					0.5	0.5
24.0					(21.2m)	0.35

ON OUTRIGGERS MIDDLE EXTENDED 4.8 m SPREAD 360° ROTATION (Unit: x 1,000 kg)						
B \ A	6.5	10.7	14.9	19.1	23.3	27.5
2.5	20.0	12.0	9.0	7.0		
3.0	16.0	12.0	9.0	7.0		
3.5	14.0	12.0	9.0	7.0	5.0	3.5
4.0	12.5	12.0	9.0	7.0	5.0	3.5
4.5	11.7	11.1	9.0	6.6	4.95	3.5
5.0	(4.4m)	10.2	8.9	6.35	4.7	3.5
5.5		9.05	8.2	6.3	4.4	3.35
6.0		7.65	7.2	6.2	4.2	3.2
7.0		5.6	5.6	5.65	4.0	2.95
8.0		4.3	4.25	4.6	3.9	2.8
9.0		3.7	3.35	3.75	3.7	2.75
10.0		(8.6m)	2.65	3.05	3.25	2.65
11.0			2.1	2.5	2.7	2.4
12.0			1.65	2.05	2.25	2.2
13.0			1.35	1.65	1.85	2.05
14.0			(12.8m)	1.3	1.55	1.75
15.0				1.05	1.3	1.45
16.0				0.85	1.1	1.25
17.0				0.7	0.9	1.05
18.0					0.75	0.9
19.0					0.6	0.75
20.0					0.5	0.6
22.0						0.4

A: Boom length (m)

B: Load radius (m)

GR-200EX RATED LIFTING CAPACITIES

ON OUTRIGGERS MIDDLE EXTENDED 4.4 m SPREAD 360° ROTATION (Unit: x 1,000 kg)						
B \ A	6.5	10.7	14.9	19.1	23.3	27.5
2.5	20.0	12.0	9.0	7.0		
3.0	16.0	12.0	9.0	7.0		
3.5	14.0	12.0	9.0	7.0	5.0	3.5
4.0	12.5	12.0	9.0	7.0	5.0	3.5
4.5	11.55	11.1	9.0	6.6	4.95	3.5
5.0	(4.4m)	9.0	8.25	6.35	4.7	3.5
5.5		7.6	7.05	6.3	4.4	3.35
6.0		6.45	6.15	6.15	4.2	3.2
7.0		4.75	4.75	4.85	4.0	2.95
8.0		3.6	3.65	3.9	3.9	2.8
9.0		3.05	2.8	3.15	3.3	2.75
10.0		(8.6m)	2.2	2.5	2.75	2.65
11.0			1.7	2.0	2.3	2.4
12.0			1.3	1.65	1.9	2.0
13.0			1.05	1.3	1.55	1.7
14.0			(12.8m)	1.05	1.3	1.45
15.0				0.85	1.05	1.2
16.0				0.65	0.85	1.0
17.0				0.5	0.7	0.8
18.0					0.55	0.7
19.0					0.45	0.55
20.0						0.45

ON OUTRIGGERS MIDDLE EXTENDED 3.2 m SPREAD 360° ROTATION (Unit: x 1,000 kg)						
B \ A	6.5	10.7	14.9	19.1	23.3	27.5
2.5	16.0	12.0	9.0	7.0		
3.0	14.15	11.6	9.0	7.0		
3.5	10.2	9.2	7.9	7.0	5.0	3.5
4.0	7.75	7.5	6.5	6.35	5.0	3.5
4.5	6.55	6.25	5.45	5.4	4.95	3.5
5.0	(4.4m)	5.15	4.6	4.65	4.55	3.5
5.5		4.35	3.95	4.05	4.0	3.35
6.0		3.65	3.4	3.55	3.55	3.2
7.0		2.7	2.55	2.75	2.8	2.8
8.0		1.95	1.9	2.15	2.25	2.25
9.0		1.65	1.35	1.65	1.8	1.85
10.0		(8.6m)	0.95	1.3	1.45	1.5
11.0			0.65	0.95	1.15	1.25
12.0			0.35	0.7	0.9	1.0
13.0				0.45	0.65	0.8
14.0				0.3	0.5	0.65
15.0					0.35	0.45

A: Boom length (m)

B: Load radius (m)

GR-200EX RATED LIFTING CAPACITIES

ON OUTRIGGERS MINIMUM EXTENDED 1.79 m SPREAD 360° ROTATION (Unit: x 1,000 kg)						
A \ B	6.5	10.7	14.9	19.1	23.3	27.5
2.5	6.55	5.65	4.7	4.55		
3.0	5.45	4.35	3.65	3.65		
3.5	4.15	3.4	2.85	2.95	2.9	2.8
4.0	3.15	2.7	2.25	2.4	2.4	2.35
4.5	2.6 (4.4m)	2.15	1.8	2.0	2.05	2.0
5.0		1.75	1.4	1.65	1.7	1.7
5.5		1.4	1.1	1.35	1.45	1.45
6.0		1.1	0.8	1.1	1.2	1.25
7.0		0.6	0.4	0.65	0.8	0.9

A: Boom length (m)

B: Load radius (m)

Note:

Standard number of parts of line for each boom length is as shown below.

Load per line should not surpass 28.4 kN (2,900 kgf) for main winch and 31.4 kN (3,200 kgf) for auxiliary winch.

Boom length	6.5 m	10.7 m	14.9 m to 27.5 m	Single top/jib
Number of parts of line	7	6	4	1

The lifting capacity data stored in the Automatic Moment Limiter (AML-E) is based on the standard number of parts of line listed in the chart.

GR-200EX RATED LIFTING CAPACITIES

ON OUTRIGGERS FULLY EXTENDED 5.2 m SPREAD 360° ROTATION (Unit: x 1,000 kg)																	
C	27.5-m Boom + 4.5-m Jib								C	27.5-m Boom + 6.9-m Jib							
	5° Offset		25° Offset		45° Offset		60° Offset			5° Offset		25° Offset		45° Offset		60° Offset	
	R	W	R	W	R	W	R	W		R	W	R	W	R	W	R	W
82.5	3.9	2.0	5.6	2.0	6.7	1.55	7.2	1.2	82.5	4.5	1.5	7.0	1.3	8.6	0.82	9.7	0.69
75	8.4	2.0	9.9	1.7	10.8	1.4	11.2	1.15	75	9.2	1.5	11.5	1.05	12.9	0.75	13.8	0.66
70	11.2	1.95	12.5	1.5	13.4	1.25	13.6	1.1	70	12.3	1.5	14.3	0.96	15.6	0.72	16.4	0.65
65	13.8	1.65	15.1	1.3	15.8	1.15	16.0	1.1	65	15.1	1.3	17.0	0.88	18.1	0.69	18.9	0.64
60	16.2	1.35	17.4	1.2	18.1	1.1	18.2	1.1	60	17.7	1.1	19.6	0.82	20.5	0.67	21.1	0.64
55	18.4	1.0	19.6	0.95	20.1	0.95			55	20.1	0.89	21.9	0.77	22.7	0.66		
50	20.5	0.73	21.5	0.69	21.9	0.69			50	22.4	0.64	24.0	0.6	24.6	0.59		
45	22.4	0.5	23.3	0.48	23.5	0.48			45	24.4	0.44	25.8	0.41	26.1	0.4		
40	24.1	0.32	24.9	0.31					40	26.2	0.27	27.4	0.27				
35	25.6	0.19	26.2	0.19					35	27.8	0.16						

ON OUTRIGGERS MIDDLE EXTENDED 4.8 m SPREAD 360° ROTATION (Unit: x 1,000 kg)																	
C	27.5-m Boom + 4.5-m Jib								C	27.5-m Boom + 6.9-m Jib							
	5° Offset		25° Offset		45° Offset		60° Offset			5° Offset		25° Offset		45° Offset		60° Offset	
	R	W	R	W	R	W	R	W		R	W	R	W	R	W	R	W
82.5	3.9	2.0	5.6	2.0	6.7	1.55	7.2	1.2	82.5	4.5	1.5	7.0	1.3	8.6	0.82	9.7	0.69
75	8.4	2.0	9.9	1.7	10.8	1.4	11.2	1.15	75	9.2	1.5	11.5	1.05	12.9	0.75	13.8	0.66
70	11.2	1.95	12.5	1.5	13.4	1.25	13.6	1.1	70	12.3	1.5	14.3	0.96	15.6	0.72	16.4	0.65
65	13.8	1.65	15.1	1.3	15.8	1.15	16.0	1.1	65	15.1	1.3	17.0	0.88	18.1	0.69	18.9	0.64
60	16.1	1.15	17.4	1.05	18.1	1.05	18.1	1.0	60	17.7	1.05	19.6	0.82	20.5	0.67	21.1	0.64
55	18.3	0.84	19.5	0.78	20.0	0.76			55	20.1	0.76	21.9	0.69	22.7	0.66		
50	20.4	0.56	21.4	0.52	21.8	0.51			50	22.3	0.49	23.9	0.46	24.5	0.45		
45	22.3	0.35	23.2	0.33	23.5	0.32			45	24.3	0.3	25.7	0.28	26.1	0.28		
40	24.0	0.19	24.8	0.18					40	26.1	0.16	27.3	0.15				

ON OUTRIGGERS MIDDLE EXTENDED 4.4 m SPREAD 360° ROTATION (Unit: x 1,000 kg)																	
C	27.5-m Boom + 4.5-m Jib								C	27.5-m Boom + 6.9-m Jib							
	5° Offset		25° Offset		45° Offset		60° Offset			5° Offset		25° Offset		45° Offset		60° Offset	
	R	W	R	W	R	W	R	W		R	W	R	W	R	W	R	W
82.5	3.9	2.0	5.6	2.0	6.7	1.55	7.2	1.2	82.5	4.5	1.5	7.0	1.3	8.6	0.82	9.7	0.69
75	8.4	2.0	9.9	1.7	10.8	1.4	11.2	1.15	75	9.2	1.5	11.5	1.05	12.9	0.75	13.8	0.66
70	11.2	1.95	12.5	1.5	13.4	1.25	13.6	1.1	70	12.3	1.5	14.3	0.96	15.6	0.72	16.4	0.65
65	13.6	1.3	15.0	1.15	15.8	1.1	16.0	1.05	65	15.1	1.3	17.0	0.88	18.1	0.69	18.9	0.64
60	16.0	0.9	17.2	0.82	17.9	0.82	18.0	0.77	60	17.6	0.87	19.5	0.79	20.5	0.67	21.1	0.64
55	18.2	0.62	19.4	0.58	19.9	0.58			55	20.0	0.57	21.7	0.51	22.5	0.51		
50	20.3	0.39	21.3	0.36	21.7	0.35			50	22.2	0.35	23.7	0.3	24.3	0.3		
45	22.2	0.19	23.1	0.18	23.4	0.18			45	24.2	0.18	25.6	0.13	26.0	0.13		

ON OUTRIGGERS MIDDLE EXTENDED 3.2 m SPREAD 360° ROTATION (Unit: x 1,000 kg)																	
C	27.5-m Boom + 4.5-m Jib								C	27.5-m Boom + 6.9-m Jib							
	5° Offset		25° Offset		45° Offset		60° Offset			5° Offset		25° Offset		45° Offset		60° Offset	
	R	W	R	W	R	W	R	W		R	W	R	W	R	W	R	W
82.5	3.9	2.0	5.6	2.0	6.7	1.55	7.2	1.2	82.5	4.5	1.5	7.0	1.3	8.6	0.82	9.7	0.69
75	8.4	1.85	9.9	1.55	10.8	1.4	11.2	1.15	75	9.2	1.5	11.5	1.05	12.9	0.75	13.8	0.66
70	10.9	1.05	12.3	0.91	13.3	0.85	13.6	0.84	70	12.4	0.93	14.3	0.78	15.6	0.71	16.4	0.65
65	13.4	0.54	14.7	0.47	15.5	0.44	15.7	0.44	65	15.0	0.47	16.8	0.4	18.0	0.37	18.7	0.36
60	15.8	0.19	17.0	0.16	17.6	0.15	17.7	0.15	60	17.5	0.16	19.1	0.12	20.1	0.11	20.7	0.11

C: Load boom angle (°)

R: Load radius (m)

W: Rated lifting capacity (Unit: x 1,000 kg)

GR-200EX RATED LIFTING CAPACITIES

ON OUTRIGGERS FULLY EXTENDED 5.2 m SPREAD 360° ROTATION (Unit: x 1,000 kg)																	
C	23.3-m Boom + 4.5-m Jib								C	23.3-m Boom + 6.9-m Jib							
	5° Offset		25° Offset		45° Offset		60° Offset			5° Offset		25° Offset		45° Offset		60° Offset	
	R	W	R	W	R	W	R	W		R	W	R	W	R	W	R	W
82.5	3.2	2.0	4.8	2.0	5.9	1.55	6.4	1.2	82.5	3.7	1.5	6.1	1.3	7.8	0.82	8.8	0.69
75	6.9	2.0	8.4	1.9	9.3	1.45	9.7	1.15	75	7.8	1.5	9.9	1.05	11.4	0.75	12.2	0.66
70	9.3	2.0	10.7	1.75	11.5	1.4	11.8	1.1	70	10.4	1.5	12.4	0.96	13.7	0.72	14.4	0.65
65	11.5	2.0	12.8	1.65	13.6	1.4	13.7	1.1	65	12.8	1.4	14.7	0.88	15.8	0.69	16.4	0.64
60	13.7	1.85	14.9	1.55	15.5	1.35	15.6	1.1	60	15.1	1.2	16.9	0.82	17.8	0.67	18.3	0.64
55	15.6	1.4	16.7	1.3	17.3	1.3			55	17.3	1.05	18.9	0.77	19.7	0.66		
50	17.4	1.05	18.4	1.0	18.8	1.0			50	19.3	0.96	20.7	0.74	21.3	0.66		
45	19.1	0.82	20.0	0.79	20.2	0.79			45	21.0	0.71	22.4	0.67	22.8	0.64		
40	20.6	0.61	21.3	0.59					40	22.7	0.52	23.8	0.5				
35	21.9	0.45	22.5	0.44					35	24.1	0.38	25.0	0.37				
30	23.1	0.33	23.5	0.32					30	25.3	0.27	26.1	0.27				
25	24.0	0.24	24.4	0.24					25	26.4	0.19	26.9	0.19				
20	24.8	0.17							20								

ON OUTRIGGERS MIDDLE EXTENDED 4.8 m SPREAD 360° ROTATION (Unit: x 1,000 kg)																	
C	23.3-m Boom + 4.5-m Jib								C	23.3-m Boom + 6.9-m Jib							
	5° Offset		25° Offset		45° Offset		60° Offset			5° Offset		25° Offset		45° Offset		60° Offset	
	R	W	R	W	R	W	R	W		R	W	R	W	R	W	R	W
82.5	3.2	2.0	4.8	2.0	5.9	1.55	6.4	1.2	82.5	3.7	1.5	6.1	1.3	7.8	0.82	8.8	0.69
75	6.9	2.0	8.4	1.9	9.3	1.45	9.7	1.15	75	7.8	1.5	9.9	1.05	11.4	0.75	12.2	0.66
70	9.3	2.0	10.7	1.75	11.5	1.4	11.8	1.1	70	10.4	1.5	12.4	0.96	13.7	0.72	14.4	0.65
65	11.5	2.0	12.8	1.65	13.6	1.4	13.7	1.1	65	12.8	1.4	14.7	0.88	15.8	0.69	16.4	0.64
60	13.6	1.65	14.9	1.5	15.5	1.35	15.6	1.1	60	15.1	1.2	16.9	0.82	17.8	0.67	18.3	0.64
55	15.6	1.2	16.7	1.15	17.2	1.1			55	17.3	1.05	18.9	0.77	19.7	0.66		
50	17.4	0.91	18.4	0.85	18.8	0.84			50	19.2	0.77	20.7	0.71	21.3	0.66		
45	19.0	0.64	19.9	0.61	20.2	0.61			45	21.0	0.54	22.3	0.5	22.7	0.48		
40	20.5	0.45	21.3	0.43					40	22.6	0.37	23.8	0.35				
35	21.9	0.3	22.5	0.29					35	24.1	0.24	25.0	0.23				
30	23.0	0.19	23.5	0.18					30	25.3	0.14						

ON OUTRIGGERS MIDDLE EXTENDED 4.4 m SPREAD 360° ROTATION (Unit: x 1,000 kg)																	
C	23.3-m Boom + 4.5-m Jib								C	23.3-m Boom + 6.9-m Jib							
	5° Offset		25° Offset		45° Offset		60° Offset			5° Offset		25° Offset		45° Offset		60° Offset	
	R	W	R	W	R	W	R	W		R	W	R	W	R	W	R	W
82.5	3.2	2.0	4.8	2.0	5.9	1.55	6.4	1.2	82.5	3.7	1.5	6.1	1.3	7.8	0.82	8.8	0.69
75	6.9	2.0	8.4	1.9	9.3	1.45	9.7	1.15	75	7.8	1.5	9.9	1.05	11.4	0.75	12.2	0.66
70	9.3	2.0	10.7	1.75	11.5	1.4	11.8	1.1	70	10.4	1.5	12.4	0.96	13.7	0.72	14.4	0.65
65	11.5	1.75	12.8	1.5	13.6	1.4	13.7	1.1	65	12.8	1.4	14.7	0.88	15.8	0.69	16.4	0.64
60	13.6	1.26	14.8	1.1	15.4	1.05	15.5	1.0	60	15.1	1.2	16.9	0.82	17.8	0.67	18.3	0.64
55	15.6	0.91	16.6	0.84	17.1	0.8			55	17.2	0.85	18.9	0.77	19.7	0.66		
50	17.4	0.66	18.3	0.63	18.7	0.61			50	19.2	0.63	20.7	0.54	21.3	0.52		
45	19.0	0.48	19.8	0.42	20.1	0.42			45	21.0	0.42	22.3	0.35	22.7	0.35		
40	20.5	0.31	21.2	0.25					40	22.6	0.26	23.7	0.21				
35	21.9	0.17							35								

ON OUTRIGGERS MIDDLE EXTENDED 3.2 m SPREAD 360° ROTATION (Unit: x 1,000 kg)																	
C	23.3-m Boom + 4.5-m Jib								C	23.3-m Boom + 6.9-m Jib							
	5° Offset		25° Offset		45° Offset		60° Offset			5° Offset		25° Offset		45° Offset		60° Offset	
	R	W	R	W	R	W	R	W		R	W	R	W	R	W	R	W
82.5	3.2	2.0	4.8	2.0	5.9	1.55	6.4	1.2	82.5	3.7	1.5	6.1	1.3	7.8	0.82	8.8	0.69
75	6.9	2.0	8.3	1.7	9.3	1.4	9.7	1.15	75	7.8	1.5	9.9	1.05	11.4	0.75	12.2	0.66
70	9.3	1.6	10.6	1.35	11.5	1.25	11.8	1.1	70	10.4	1.35	12.4	0.96	13.7	0.72	14.4	0.65
65	11.5	0.95	12.7	0.84	13.4	0.79	13.7	0.77	65	12.8	0.83	14.7	0.7	15.8	0.64	16.4	0.63
60	13.6	0.52	14.6	0.46	15.3	0.44	15.4	0.43	60	15.0	0.45	16.7	0.38	17.7	0.35	18.1	0.35
55	15.6	0.22	16.5	0.19	17.0	0.18			55	17.1	0.18	18.7	0.14	19.5	0.13		

C: Load boom angle (°)

R: Load radius (m)

W: Rated lifting capacity (Unit: x 1,000 kg)

GR-200EX RATED LIFTING CAPACITIES

ON RUBBER STATIONARY								
A \ B	Over Front				360° Rotation			
	6.5	10.7	14.9	19.1	6.5	10.7	14.9	19.1
3.0	3.7	3.6	3.55	3.7	2.3	2.3	2.3	2.3
3.5	3.2	3.1	3.1	3.25	1.9	1.8	1.8	2.0
4.0	2.8	2.7	2.7	2.85	1.6	1.4	1.4	1.6
4.5	2.55	2.4	2.35	2.5	1.3	1.1	1.05	1.3
5.0	(4.4m)	2.1	2.05	2.2	(4.4m)	0.8	0.75	1.1
5.5		1.85	1.8	2.0		0.5	0.45	0.85
6.0		1.6	1.6	1.75				0.6
7.0		1.25	1.25	1.4				
8.0		1.0	0.9	1.1				
9.0			0.65	0.8				
10.0			0.4	0.6				
11.0			0.25	0.4				
12.0				0.25				
13.0				0.15				

ON RUBBER CREEP								
A \ B	Over Front				360° Rotation			
	6.5	10.7	14.9	19.1	6.5	10.7	14.9	19.1
3.0	2.6	2.6	2.6	2.6	1.6	1.6	1.6	1.6
3.5	2.3	2.2	2.2	2.3	1.3	1.2	1.2	1.3
4.0	1.9	1.9	1.9	2.0	1.0	0.9	0.9	1.1
4.5	1.7	1.6	1.6	1.8	0.9	0.7	0.7	0.9
5.0	(4.4m)	1.4	1.4	1.6	(4.4m)	0.6	0.5	0.7
5.5		1.2	1.2	1.4		0.35	0.3	0.6
6.0		1.1	1.1	1.2				0.45
7.0		0.8	0.8	1.0				
8.0		0.6	0.6	0.8				
9.0			0.45	0.6				
10.0			0.3	0.45				
11.0				0.35				

A: Boom length (m)
 B: Load radius (m)

Note:
 The lifting capacity data stored in the Automatic Moment Limiter (AML-E) is based on the standard number of parts of line listed in the chart. Standard number of parts of line for on rubber operation should be according to the following table.

Boom length	6.5 m to 19.1 m	Single top
Number of parts of line	4	1

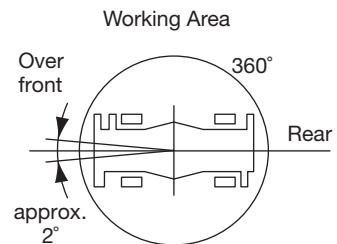

WARNING AND OPERATING INSTRUCTIONS FOR ON RUBBER LIFTING CAPACITIES

1. Rated lifting capacities based on crane stability are according to ISO4305.
2. Rated lifting capacities shown in the chart are based on the condition that crane is set on firm level surfaces with suspension lock applied. They are based on actual load radius increased by tire deformation and boom deflection.
3. If the suspension lock cylinders contain air, the axle will not be locked completely and rated lifting capacities may not be obtainable. Bleed the cylinders according to the operation safety and maintenance manual.
4. Rated lifting capacities are based on proper tire inflation, capacity and condition. Damaged tires are hazardous to safe operation of crane.
5. Tires shall be inflated to correct air pressure.

Tires	Air Pressure
445/80R25	700 kPa

6. Over front operation shall be performed within 2 degrees in front of chassis.

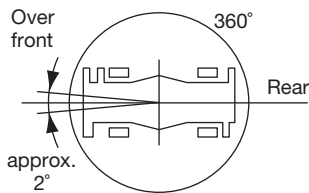

7. On rubber lifting with "jib" is not permitted. Maximum permissible boom length is 19.1 m.

8. When making lift on rubber stationary, set parking brake.
9. For creep operation, travel slowly and keep the lifted load as close to the ground as possible, and especially avoid any abrupt steering, accelerating or braking.
10. Do not operate the crane while carrying the load.
11. Creep is motion for crane not to travel more than 60 m in any 30 minutes period and to travel at the speed of less than 1.6 km/h.
12. For creep operation, choose the drive mode and proper gear according to the road or working condition.
13. The mass of the hook (175 kg for 20 t capacity, 50 kg for 3.2 t capacity), slings and all similarly used load handling devices must be considered as part of the load and must be deducted from the lifting capacities.
14. For rated lifting capacity of single top, reduce 125 kg from the rated lifting capacities of relevant boom according to a weight reduction for auxiliary load handling equipment. Capacities of single top shall not exceed 3,200 kg including main hook.
15. The lifting capacity data stowed in the Automatic Moment Limiter (AML-E) is based on the standard number of parts of line listed in the chart. Standard number of parts of line for on rubber operation should be according to the following table.

Boom length in meters	6.5 m	10.7 m	14.9 m	19.1 m	Single top
Number of parts of line	4	4	4	4	1

WARNING AND OPERATING INSTRUCTIONS FOR LIFTING CAPACITIES

GENERAL

1. RATED LIFTING CAPACITIES apply only to the machine as originally manufactured and normally equipped by TADANO LTD. Modifications to the machine or use of optional equipment other than that specified can result in a reduction of capacity.
2. Hydraulic cranes can be hazardous if improperly operated or maintained. Operation and maintenance of this machine must be in compliance with information in the **Operation and Maintenance Manual** supplied with the crane. If this manual is missing, order a replacement through the distributor.

SET UP

1. Rated lifting capacities on the chart are the maximum allowable crane capacities and are based on the machine standing level on firm supporting surface under ideal job conditions. Depending on the nature of the supporting surface, it may be necessary to have structural supports under the outrigger floats or tires to spread the loads to a larger bearing surface.
2. For outrigger operation, outriggers shall be properly extended with tires free of supporting surface before operating crane.

OPERATION

1. Rated lifting capacities on outriggers fully extended as determined by ISO4305.
2. They are based on actual load radius increased by boom deflection.
3. The weight of handling device such as hook blocks (175 kg for 20 t capacity, 50 kg for 3.2 t capacity), slings, etc., must be considered as part of the load and must be deducted from the lifting capacities.
4. Rated lifting capacities are based on freely suspended loads and make no allowance for such factors as the effect of wind, sudden stopping of loads, supporting surface conditions, inflation of tires, operating speeds, side loads, etc. Side pull on the boom or jib is extremely dangerous. Such action can damage the boom, jib or slewing mechanism, and lead to overturning of the crane.
5. Rated lifting capacities do not account for wind on lifted load or boom. We recommend against working under the conditions that the load is out of control due to a strong wind. During boom lift, consider that the rated lifting capacity is reduced by 50% when the wind speed is 9 m/s to 12 m/s, reduced by 70 % when the wind speed is 12 m/s to 14 m/s. If the wind speed is 14 m/s or over, stop operation. During jib lift, stop operation if the wind speed is 9 m/s or over.
6. Rated lifting capacities at load radius shall not be exceeded. Do not tip the crane to determine allowable loads.
7. Do not operate at boom lengths, radii, or boom angles, where no capacities are shown. Crane may overturn without any load on the hook.
8. When boom length is between values listed, refer to the rated lifting capacities of the next longer and next shorter booms for the same radius. The lesser of the two rated lifting capacities shall be used.
9. When making lifts at a load radius not shown, use the next longer radius to determine allowable capacity.
10. Load per line should not surpass 28.4 kN (2,900 kgf) for main winch and 31.4 kN (3,200 kgf) for auxiliary winch.
11. Check the actual number of parts of line with Automatic Moment Limiter (AML-E) before operation. Maximum lifting capacity is restricted by the number of parts of line of Automatic Moment Limiter (AML-E). Limited capacity is as determined from the formula, Single line pull for main winch 28.4 kN (2,900 kgf) x number of parts of line.
12. The boom angle before loading should be greater to account for deflection. For rated lifting capacities, the loaded boom angle and the load radius is for reference only.

13. The 6.5-m Boom length capacities are based on boom fully retracted.
14. Extension or retraction of the boom with loads may be attempted within the limits of the RATED LIFTING CAPACITIES. The ability to telescope loads is limited by hydraulic pressure, boom angle, boom length, crane maintenance, etc.
15. For lifting capacity of single top, deduct the weight of the load handling equipment from the rated lifting capacity of the boom. For the lifting capacity of single top, the net capacity shall not exceed 3,200 kg including the main boom hook mass attached to the boom.
16. Be careful that the hoist does not stop even when overwind condition occurs while "ANTI-TWO-BLOCK DEVICE" disable switch is pushed.
17. In the case of shorter boom length than 23.3m, rated lifting capacities are determined by loaded boom angle only in the column headed "23.3-m Boom + 4.5-m Jib" or "23.3-m Boom + 6.9-m Jib" according to the jib length.
18. For angles not shown, use the next lower loaded boom angle to determine allowable capacity.
19. The lifting capacity data stored in the Automatic Moment Limiter (AML-E) is based on the standard number of parts of line listed in the chart. Standard number of parts of line for on outrigger operation should be according to the following table.

Boom length	6.5 m	10.7 m	14.9 m to 27.5 m	Single top/ jib
Number of parts of line	7	6	4	1

20. The lifting capacity for over side area differs depending on outrigger extension width. Work with capacity corresponding to the extension width. The lifting capacities for over front and over rear areas are for "outriggers fully extended". However, the areas (angle a) differ depending on the outrigger extension width.

Outriggers extended width	4.8m (middle)	4.4 m (middle)	3.2 m (middle)	1.79 m (minimum)
Angle a°	45	40	20	5

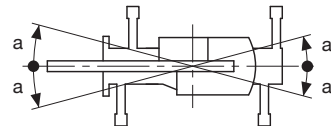

DEFINITIONS

1. Load Radius: Horizontal distance from a projection of the axis of rotation to supporting surface before loading to the center of the vertical hoist line or tackle with load applied.
2. Loaded Boom Angle: The angle between the boom base section and the horizontal, after lifting the rated lifting capacity at the load radius.
3. Working Area: Area measured in a circular arc about the centerline of rotation.
4. Freely Suspended Load: Load hanging free with no direct external force applied except by the hoist line.
5. Side Load: Horizontal side force applied to the lifted load either on the ground or in the air.

WARNING AND OPERATING INSTRUCTIONS FOR USING THE AUTOMATIC MOMENT LIMITER (AML-E)

1. Set AML select keys in accordance with the actually operating crane conditions and don't fail to make sure, before crane operation, that the displays on front panel are correct.
2. When operating crane on outriggers:
 - Set P.T.O. switch to "ON".
 - Press the outrigger state select key to register for the outrigger operation. If the display agrees with the actual state, press the set key to register. After the completion of the registration, the pop-up window closes.
 - Press the lift state select key to register the lift state to be used (single top / jib / boom).
 - Each time the lift state select key is pressed, the display changes. If the display agrees with the actual state, press the set key to register. After the completion of the registration, the pop-up window closes.
 - When erecting and stowing jib, select the status of jib set (Jib lift indicative symbol flickers).
3. When operating crane on rubber:
 - Set P.T.O. switch to "ON".
 - Press the outrigger state select key to register for the on rubber operation. Each time the outrigger state select key is pressed, the display changes. Select the creep operation, the on rubber state indicative symbol flickers.
 - Press the lift state select key to register the lift state.

However, pay attention to the following.
For stationary and creep operation.

 - The front capacities are attainable only when the over front position symbol comes on. When the boom is more than 2 degrees from centered over front of chassis, 360° capacities are in effect.
- When a load is lifted in the front position and then slewed to the side area, make sure the value of the Automatic Moment Limiter (AML-E) is below the 360° lifting capacity.
4. This machine is equipped with an automatic slewing stop device.
(For the details, see Operation and Maintenance Manual.)
But, operate very carefully because the automatic slewing stop does not work in the following cases.
 - During on rubber operation.
5. During crane operation, make sure that the displays on front panel are in accordance with actual operating conditions.
6. The displayed values of Automatic Moment Limiter (AML-E) are based on freely suspended loads and make no allowance for such factors as the effect of wind, sudden stopping of loads, supporting surface conditions, inflation of tire, operating speed, side loads, etc.
For safe operation, it is recommended when extending and lowering boom or slewing, lifting loads shall be appropriately reduced.
7. Automatic Moment Limiter (AML-E) is intended as an aid to the operator. Under no condition should it be relied upon to replace use of capacity charts and operating instruction.
Sole reliance upon Automatic Moment Limiter (AML-E) aids in place of good operating practice can cause an accident. The operator must exercise caution to assure safety.

GR-200EX Axle weight distribution chart

	Kilograms		
	GVW	Front	Rear
Basic machine	19,960	9,980	9,980
Permissible axle load	20,400	10,200	10,200



TADANO

TADANO LTD. (International Sales Division)

4-12, Kamezawa 2-chome,
Sumida-ku, Tokyo 130-0014, Japan

Tel: +81-(0)3-3621-7750

Fax: +81-(0)3-3621-7785

<http://www.tadano.com/>

info@tadano.com

Printed in Japan
2018-07-1